

Panam elegance

Pág. 326-327

OFF CLEVER



LAVABO 45 | Basin mixer 45 | Mitigeur lavabo 45

Precio erróneo - Wrong price - Prix erroné

				Ref.	€	
		ec1		96340	51,00	12
		ec1		96543	59,00	12
		ec1		97939	67,00	12



BIDÉ | Bidet mixer | Mitigeur bidet

Precio erróneo - Wrong price - Prix erroné

				Ref.	€	
		ec1		96341	51,00	12
		ec1		96544	59,00	12
		ec1		97940	67,00	12



BAÑO-DUCHA | Bath-shower mixer | Mitigeur bain-douche

Precio erróneo - Wrong price - Prix erroné

				Ref.	€	
		ec1		96342	82,00	8
		ec1		99799	72,00	8



DUCHA | Shower mixer | Mitigeur Douche

Precio erróneo - Wrong price - Prix erroné

				Ref.	€	
		ec1		96343	67,00	8
		ec1		99800	57,00	8



FREGADERO | Sink mixer | Mitigeur évier

Precio erróneo - Wrong price - Prix erroné

				Ref.	€	
		ec1		96344	72,00	12



FREGADERO | Sink mixer | Mitigeur évier

Precio erróneo - Wrong price - Prix erroné

				Ref.	€	
		ec1		96345	78,00	12



FREGADERO MURAL Wall mounted single lever sink mixer | Mitigeur évier mural

Precio erróneo - Wrong price - Prix erroné

				Ref.	€	
		ec1		96346	88,00	12

Panam xtreme

Pág. 328-329

OFF CLEVER



LAVABO 50 | Basin mixer 50 | Mitigeur lavabo 50

Precio y código erróneo - Wrong price and code -
Prix et code erronés

	ACS	SYNTHETIC	ec1	Ref.	€	
			ec1	98141	51,00	12
			ec1	98137	59,00	12
			ec1	98138	67,00	12



BIDÉ | Bidet mixer | Mitigeur bidet

Precio erróneo - Wrong price - Prix erroné

	ACS	SYNTHETIC	ec1	Ref.	€	
			ec1	98142	51,00	12
			ec1	98139	59,00	12
			ec1	98140	67,00	12



BAÑO-DUCHA | Bath-shower mixer | Mitigeur bain-douche

Precio erróneo - Wrong price - Prix erroné

	ACS	SYNTHETIC	ec1	Ref.	€	
			ec1	98143	82,00	8
			ec1	99801	72,00	8



DUCHA | Shower mixer | Mitigeur Douche

Precio erróneo - Wrong price - Prix erroné

	ACS	SYNTHETIC	ec1	Ref.	€	
			ec1	98144	67,00	8
			ec1	99802	57,00	8



FREGADERO | Sink mixer | Mitigeur évier

Precio erróneo - Wrong price - Prix erroné

	ACS	SYNTHETIC	ec1	Ref.	€	
			ec1	98767	72,00	12



FREGADERO | Sink mixer | Mitigeur évier

Precio erróneo - Wrong price - Prix erroné

	ACS	SYNTHETIC	ec1	Ref.	€	
			ec1	98145	69,00	12



FREGADERO MURAL Wall mounted single lever sink mixer | Mitigeur évier mural

Precio erróneo - Wrong price - Prix erroné

	ACS	SYNTHETIC	ec1	Ref.	€	
			ec1	98766	88,00	12



FREGADERO MURAL Wall mounted single lever sink mixer | Mitigeur évier mural

Precio erróneo - Wrong price - Prix erroné

	ACS	SYNTHETIC	ec1	Ref.	€	
			ec1	98146	84,00	12

Ventu



Pág. 22

PLATINUM



BIDÉ | Bidet mixer | Mitigeur bidet

Falta cantidad por caja - Missing quantity per box
Quantité par boîte manquante

	Ref.	€	☐
 ec1	99431	274,00	8
 ec1	99432	282,00	8
 ec1	99433	290,00	8

Agora Xtreme

Pág. 55

STYLES



Cod. 60707

LAVABO 240 NEGRO MATE | Matte black tall basin mixer 240 |
Mitigeur lavabo noir mat 240

Falta icono EasyFix - Missing EasyFix icon -
Icône EasyFix manquant



Start urban



Pág. 100

STYLES PRO



LAVABO 60 | Basin mixer 60 | Mitigeur lavabo 60

Código erróneo - Wrong code - Code erroné

	Ref.	€	☐
 C1	99153	69,00	12
 C2	98918	71,00	12
 C3	98610	73,00	12

S12 urban

Pág. 133

STYLES PRO





FREGADERO MURAL

Wall mounted sink mixer | Mitigeur évier mural

Código erróneo - Wrong code - Code erroné

	Ref.	€	☐
 ec1	60725	87,00	-

 **95174**
 **98237**
 **90025**

Fe de erratas

List of errors · Errata

Última modificación · Last modification
Dernière modification · 19/03/19

Electrónico elegance

Pág. 133

COLECTIVIDADES



elegance

LAVABO ELECTRÓNICO 120 - 1 AGUA
SENSOR TAP 120 - 1 water
LAVABO ÉLECTRONIQUE 120 - Robinet 1 eau

Ref.	€	
60740	290,00	-

Error en la descripción - Wrong description - Erreur dans la description

With2 antigona

Pág. 76

STYLES

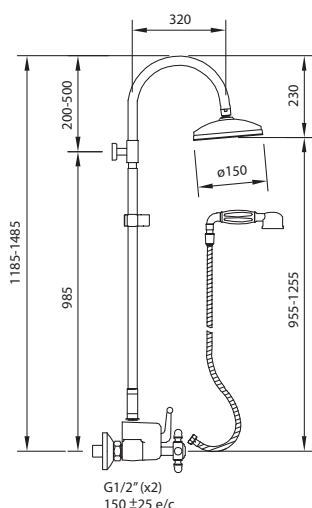

antigona

CONJUNTO DE DUCHA TERMOSTÁTICO EXTENSIBLE
Extendible Thermostatic shower system
Colonne thermostatique douche extensible

Ref.	€	
96746	576,00	3

Error en el croquis - Wrong sketch - Erreur dans le croquis

Grifería para equipos de calidad del agua

Water quality equipment taps / Robinets d'équipement de qualité d'eau

Pág. 165

COCINA



FREGADERO 3 VIAS PARA EQUIPOS DE CALIDAD DEL AGUA
3 way sink mixer for water quality equipment | Mitigeur évier
3 voies pour équipement de qualité de l'eau

Ref. 99684 - 97806

Falta información - Missing information - Information manquante

Incluye
Includes
Inclus



97399

Adaptador para tubo PE 1/4" - 7/16"-24 H.
Adapter for PE 1/4" - 7/16"-24 F pipe.
Adaptateur tubo PE 1/4" - 7/16"-24 H.

SYVARI

Pág. 246

GAMA BOX



Expositor sobremesa SYVARI Floorstand SYVARI Présentoir de comptoir SYVARI

Precio erróneo - Wrong price - Prix erroné

Ref.	€	
98885	17,50	16*

*Pack indivisible de 16 unidades)

*(Indivisible Packaging of 16 units)

*(Pack indivisible de 16 unités)